

NÁVOD

Garlist SDG-02 Zahradní domek - Šedá

S0806A -2216

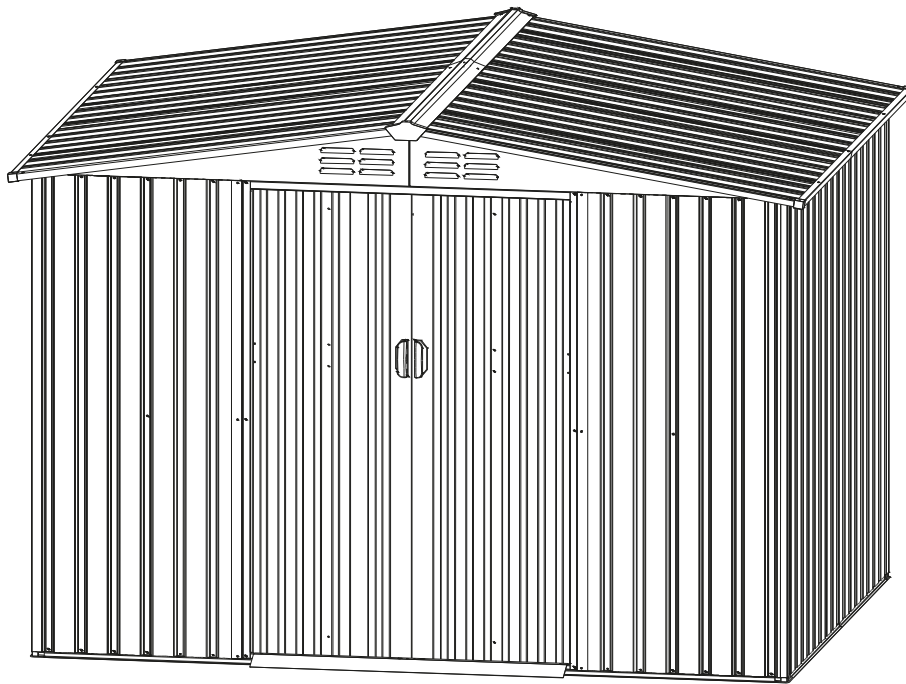

Doporučené nástroje



DŮLEŽITÉ: Uschovejte pro budoucí použití. Pečlivě si přečtěte.

PŘÍPRAVA K MONTÁŽI

Před zahájením stavby zkontrolujte místní stavební předpisy týkající se základů, umístění a dalších požadavků. Prostudujte si tento návod – obsahuje důležité informace a užitečné tipy, které usnadní a zpříjemní montáž.

Instrukce k montáži:

Před zahájením si přečtěte všechny pokyny a informace. Pro úspěšný výsledek se ujistěte, že postupujete krok za krokem podle uvedené posloupnosti.

Základ / podlaha:

Pozemek musí být připraven tak, aby základna domku byla vodorovná ze všech stran – nutná je kontrola pomocí vodováhy.

Základ může být vyroben z impregnovaného dřeva nebo betonu, aby se zabránilo pronikání vlhkosti do domku.

Domek nesmí být postaven přímo na trávu, protože zem během deště měkne a bahní. Pokud se dělá betonová deska, musí být mírně vyspádovaná k okrajům, aby se zabránilo pronikání vody. Beton musí být zcela suchý, než na něj domek postavíte.

Základna může být také vytvořena z cihel, tvárnic, nebo umístěna na betonovou desku. Cihly nebo tvárnice musí být pevně usazeny do roviny a konstrukce domku na ně následně přišroubována.

Díly a seznam dílů:

Před zahájením montáže roztřídte a zkontrolujte všechny díly a spojovací materiál, abyste měli jistotu, že nic nechybí (viz strana Seznam dílů).

Nepokoušejte se domek sestavit, pokud nějaké díly chybí.

Částečně sestavený domek může být snadno poškozen i slabým větrem.

Bezpečnost musí být na prvním místě:

Vyberte si pro montáž suchý a bezvětřný den. Na montáž jsou potřeba alespoň dvě osoby. Používejte ochranné rukavice, brýle a dlouhé rukávy, abyste předešli zranění ostrými hranami dílů.

Děti a domácí zvířata nemají na staveništi co dělat.

Nestoupejte celou vahou na střechu domku. Pokud používáte schůdky, ujistěte se, že jsou bezpečné.

Údržba a péče:

Udržujte domek čistý – používejte měkký hadřík, v případě potřeby vodu.

Udržujte dveřní kolejnice čisté, bez nečistot, aby dveře mohly hladce jezdit.

Odstraňujte sníh vhodnými nástroji, aby byl vstup bezpečný. Těžký sníh může způsobit zřícení střechy – vždy dbejte na bezpečnost.

Domek není určen k bydlení, ale pouze ke skladování věcí.

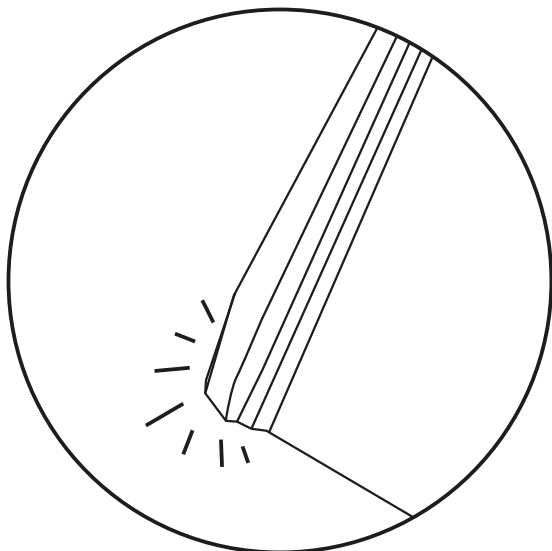

CZ – UPOZORNĚNÍ:



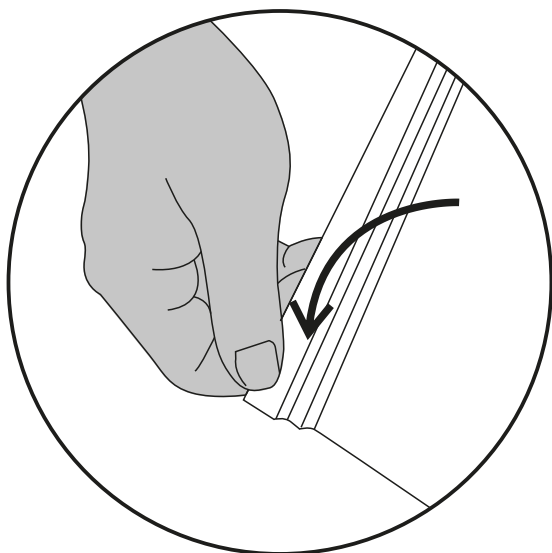



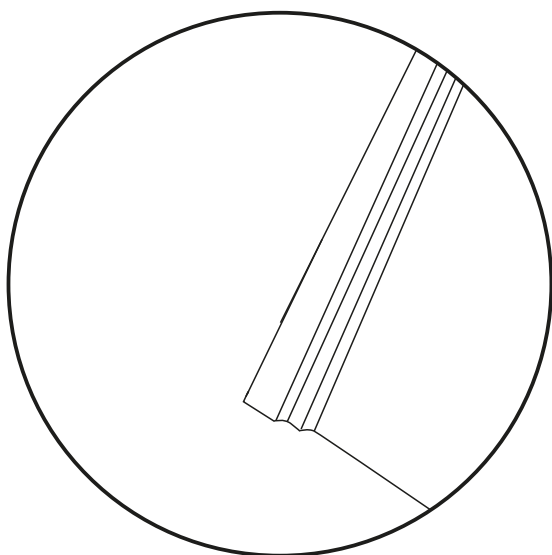



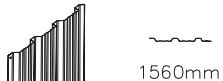
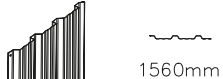
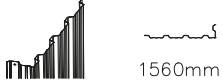
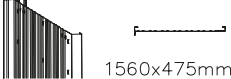

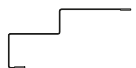
Pokud jsou rohy lehce ohnuté, je to v pořádku.

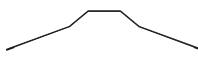



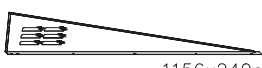
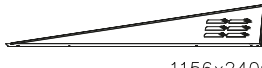
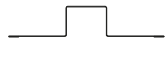

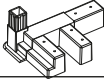
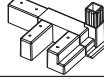





Noste rukavice a lehce narovnejte rohy,
dokud nebudou rovné.

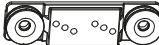











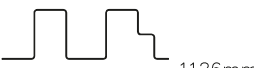
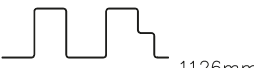







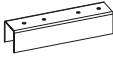

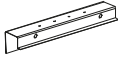





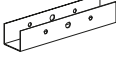

Poté budou panely zase v normálním stavu
a nebude to mít žádný vliv na montáž.

Karton:1/2		
Č.	DÍL.	P.
W3	 1560mm	15
W4	 1560mm	2
W7	 1560mm	4
M1	 1560x475mm	1
M2	 1560x475mm	1
5	 1515mm	4
17L	 1560mm	1
17R	 1560mm	1
18	 923mm	2
19L	 1171mm	2
19R	 643mm	2
20	 1253mm	4
21L	 1156x240mm	2
21R	 1156x240mm	2
22	 475mm	6
23	 980mm	1
A	 1	1
B	 1	1
C	 2	2
D	 1	1

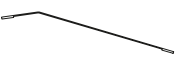
E		1
F		2
F1		4
F2		2
F3		4
F4		4
F5		2
F10		2
S9		4
F7		310

Karton:2/2



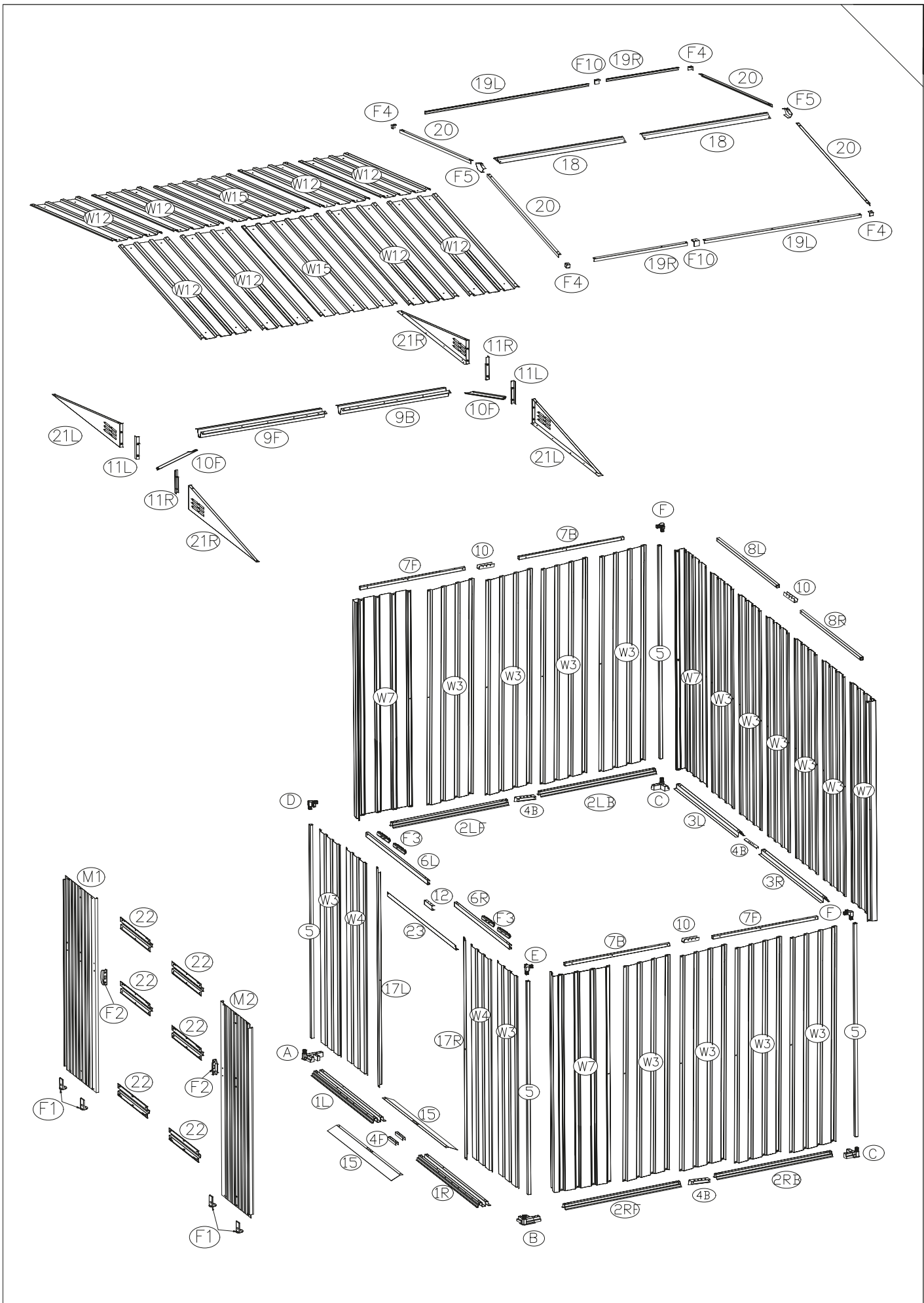

Č.	DÍL.	P.
W12	 1253mm	8
W15	 1253mm	2
1L	 1126mm	1
1R	 1126mm	1
2LF	 765mm	1
2LB	 808mm	1
2RF	 765mm	1
2RB	 808mm	1
3L	 1126mm	1
3R	 1126mm	1

4F	 120mm	2	Brožura		1
4B	 200mm	3			
6L	 1134mm	1			
6R	 1134mm	1			
7F	 816mm	2			
7B	 816mm	2			
8L	 1134mm	1			
8R	 1134mm	1			
9F	 951mm	1			
9B	 951mm	1			
10	 100mm	3			
10F	 350mm	2			
11L	 240mm	2			
11R	 240mm	2			
12	 120mm	1			
15	 920mm	2			
S4		330			
S6		90			
S7		90			
S8		16			
F8		55			
Rukavice		2			



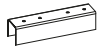

Č.	DÍL	MM	P
SPODEK			
1L		1126	1
1R		1126	1
2LF		765	1
2RF		765	1
2LB		808	1
2RB		808	1
3L		1126	1
3R		1126	1
4F		120	2
4B		200	3
15		920	2
STŘED			
W3		1560	15
W4		1560	2
W7		1560	4
5		1515	4
7F		816	2
7B		816	2
8L		1134	1
8R		1134	1
6L		1134	1
6R	1134	1	
10		100	3
12		120	1
23		980	1
TOP1			
9F		951	1
9B		951	1
10F		350	1
11L		240	2
11R		240	2

Č.	DÍL	MM	P
19L		1171	2
19R		643	2
20		1253	4
21L		1156*240	2
21R		1156*240	2
TOP2			
W12		1253	8
W15		1253	2
18		923	2
DVEŘE			
17L		1560	1
17R		1560	1
M1		1560x475	1
M2		1560x475	1
22		475	6
DÍLY			
A			1
B			1
C			2
D			1
E			1
F			2
F1			4
F2			2
F3			4
F4			4
F5			2
F7			310
F8			55
F10			2
S4			330
S6			90

1L		1
1R		1
4F		2
S4		4

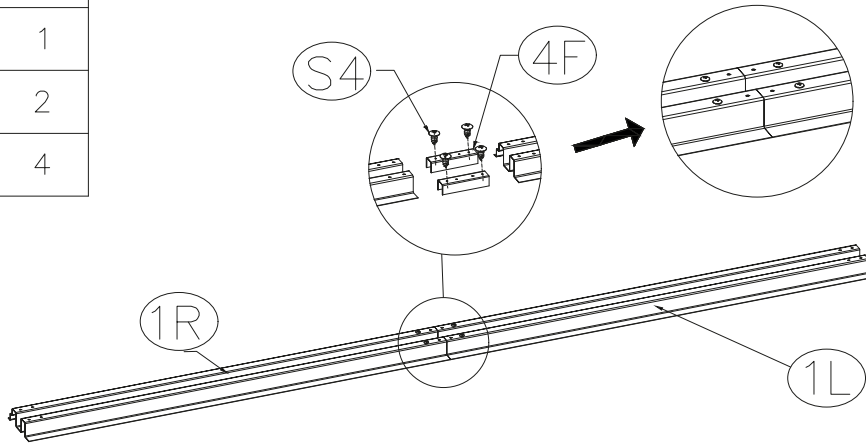

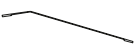

01

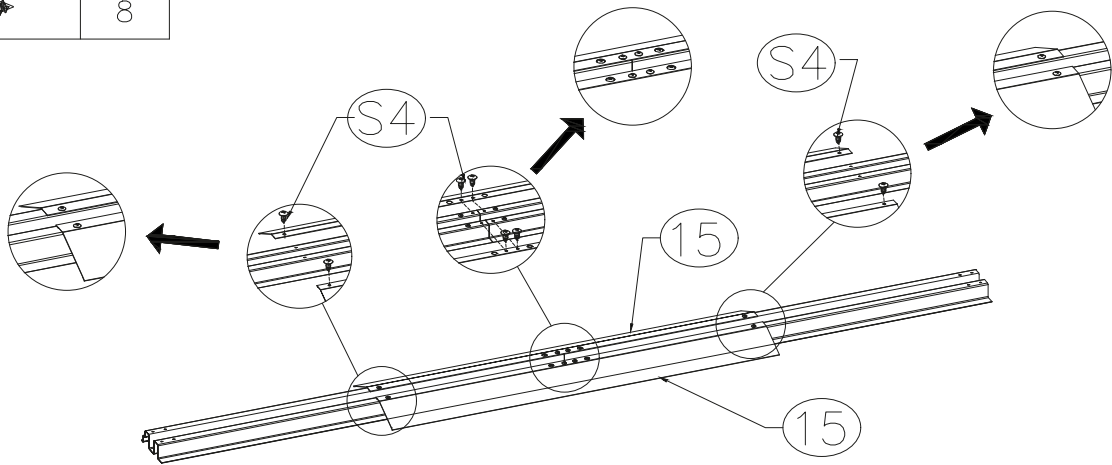

15		2
S4		8





02

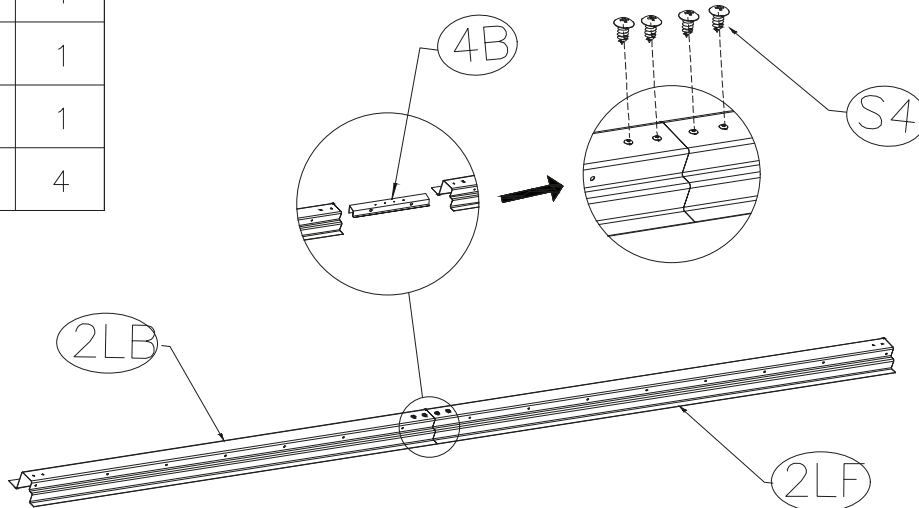

2LF		1
2LB		1
4B		1
S4		4





03

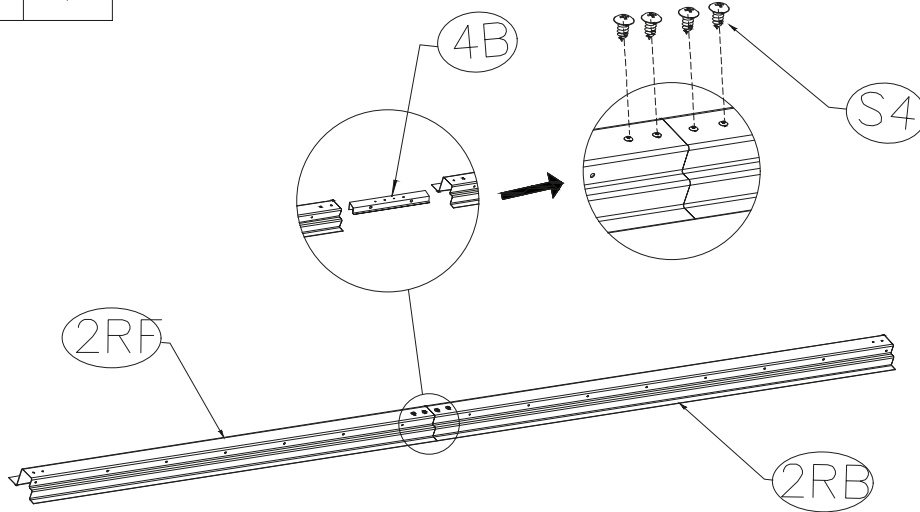

2RF		1
2RB		1
4B		1
S4		4





04

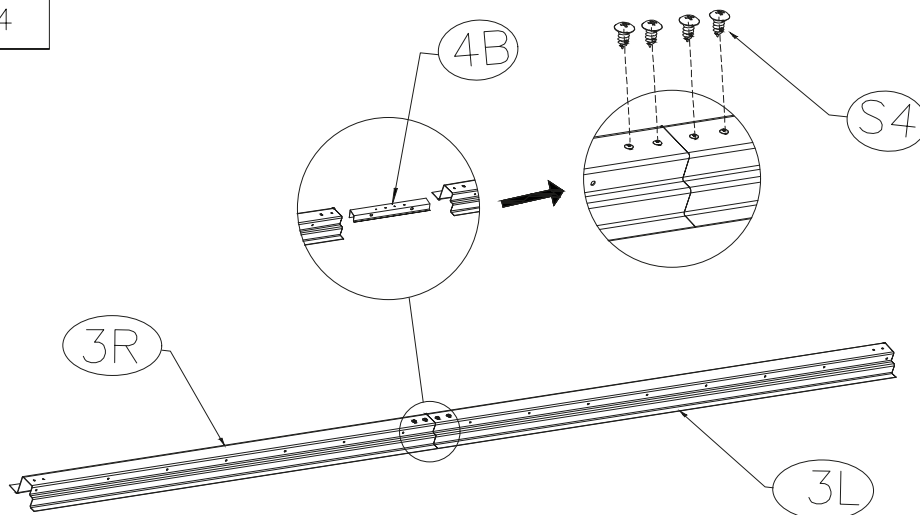

3L		1
3R		1
4B		1
S4		4

05





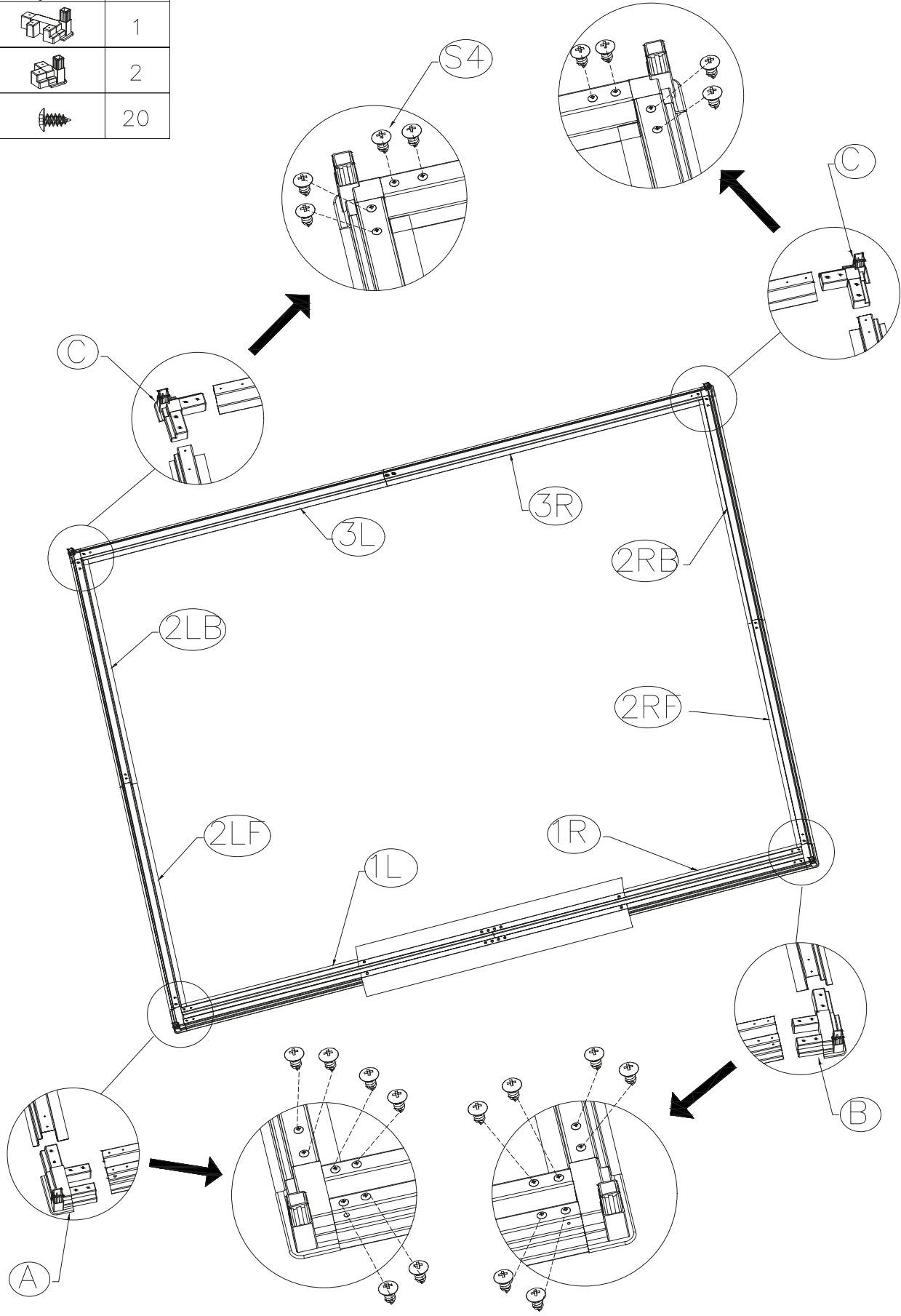



A		1
B		1
C		2
S4		20

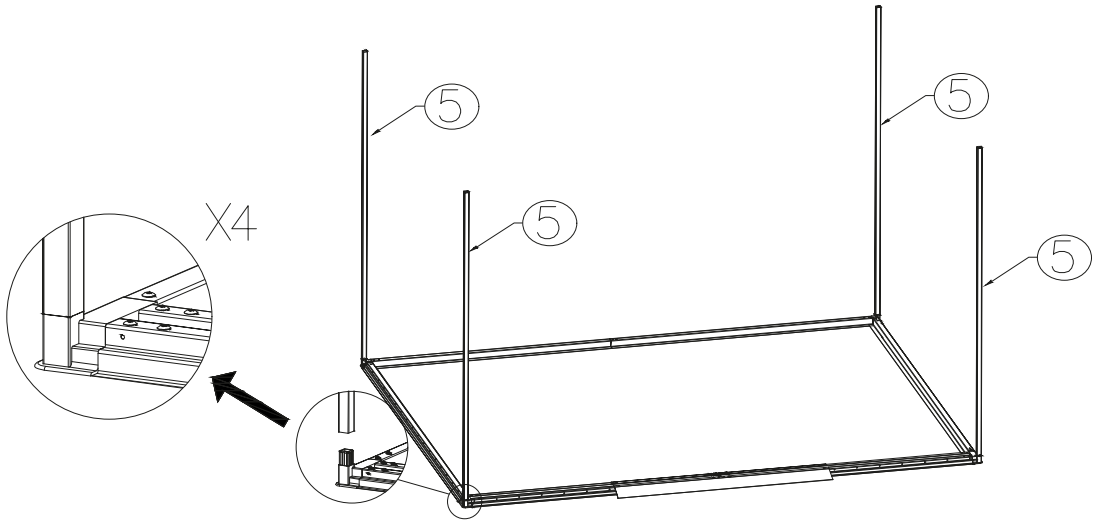

5		4
---	---	---





07

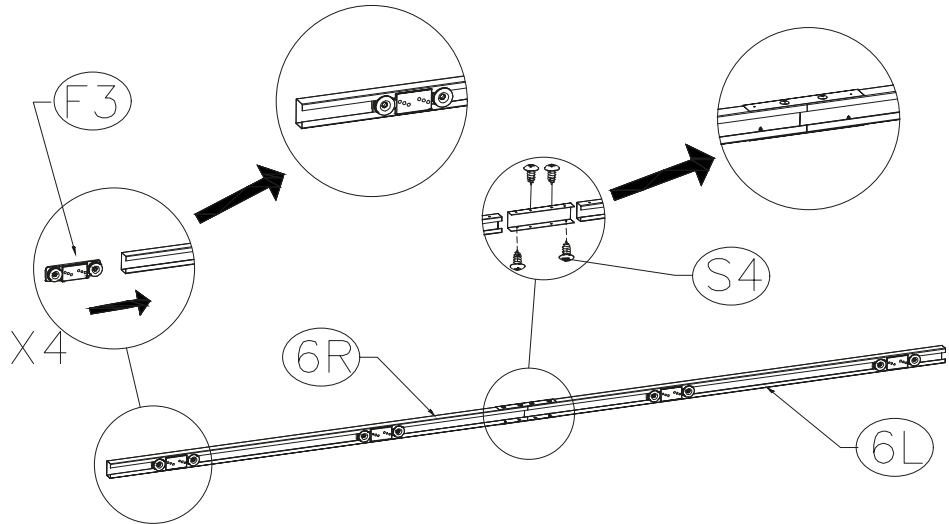

6L		1
6R		1
12		1
F3		4
S4		4





08



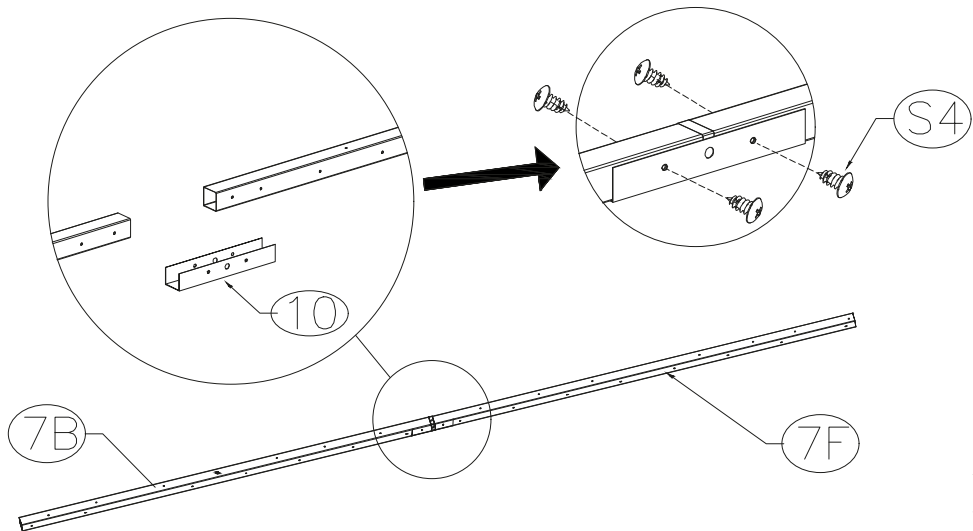
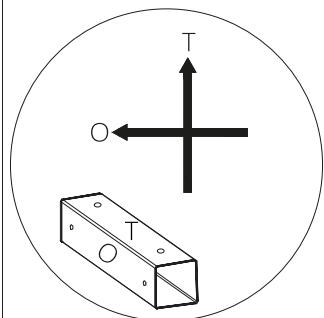



7F		2
7B		2
10		2
S4		8

09

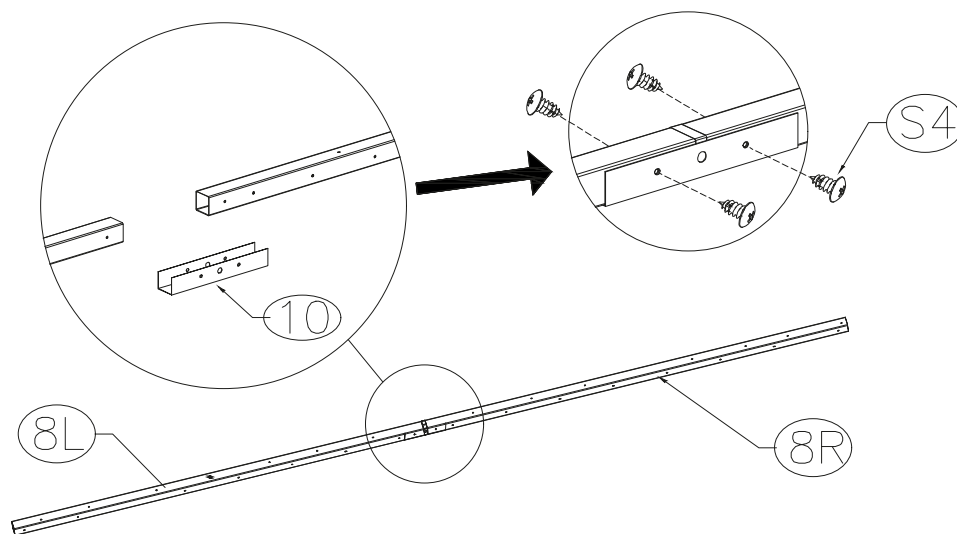
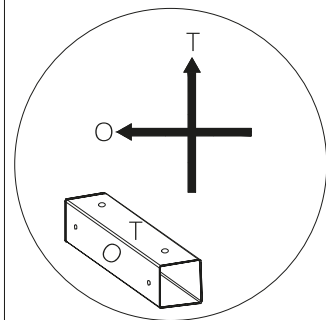



8L		1
8R		1
10		1
S4		4



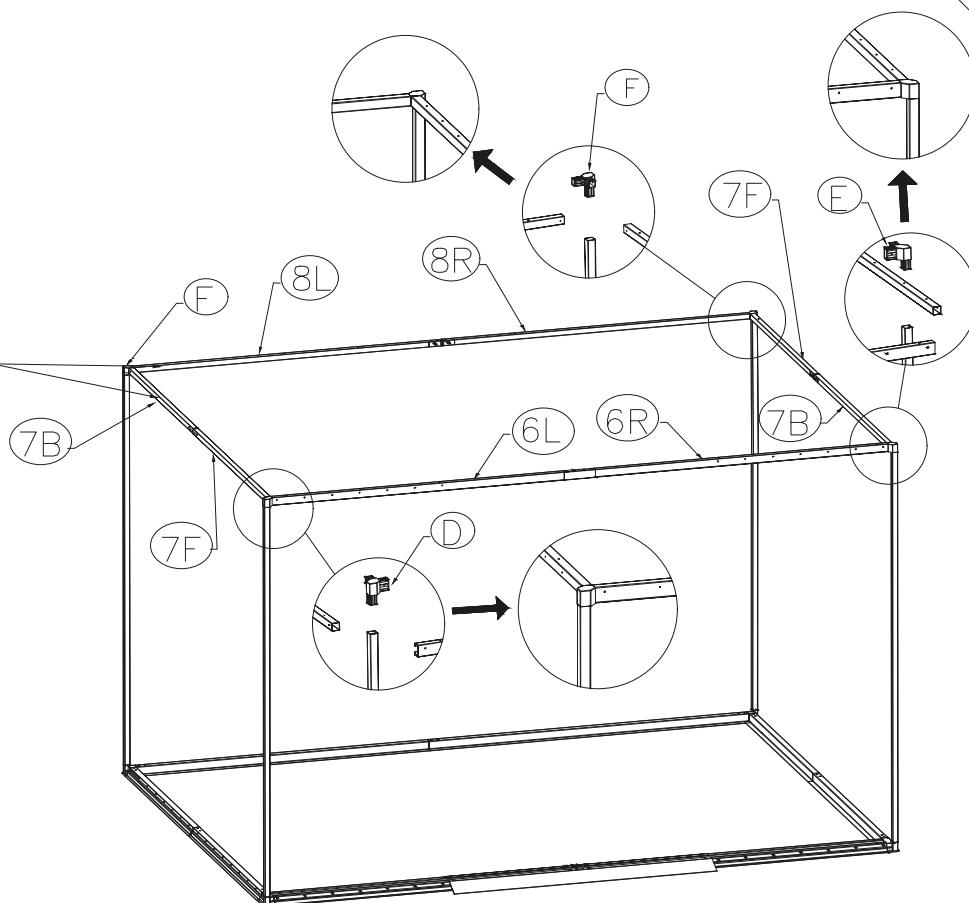
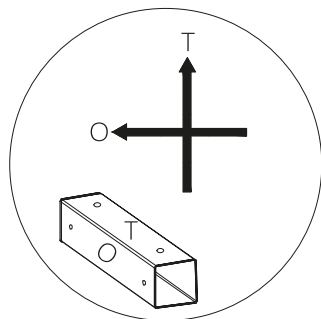



D		1
E		1
F		2



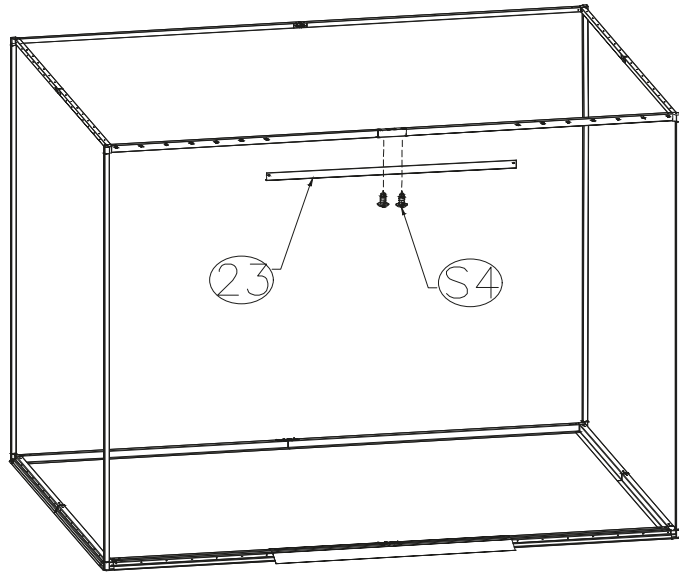



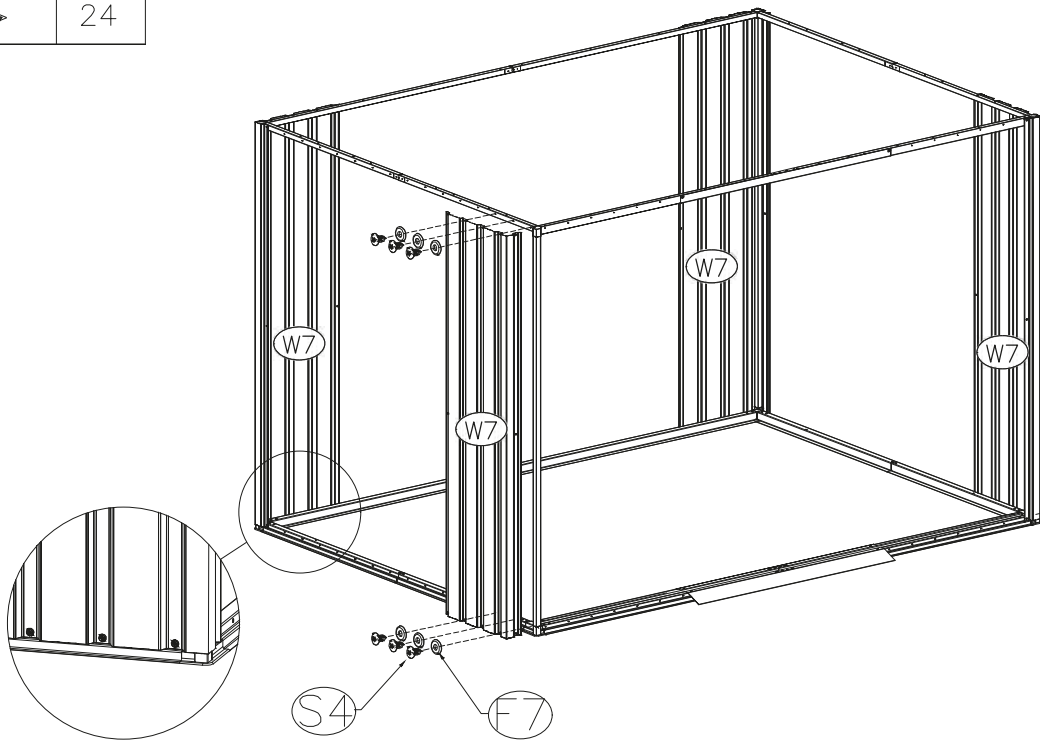

TIP: Při montáži věnujte pozornost směru otvorů!

23		1
S4		2







W7		4
F7		24
S4		24

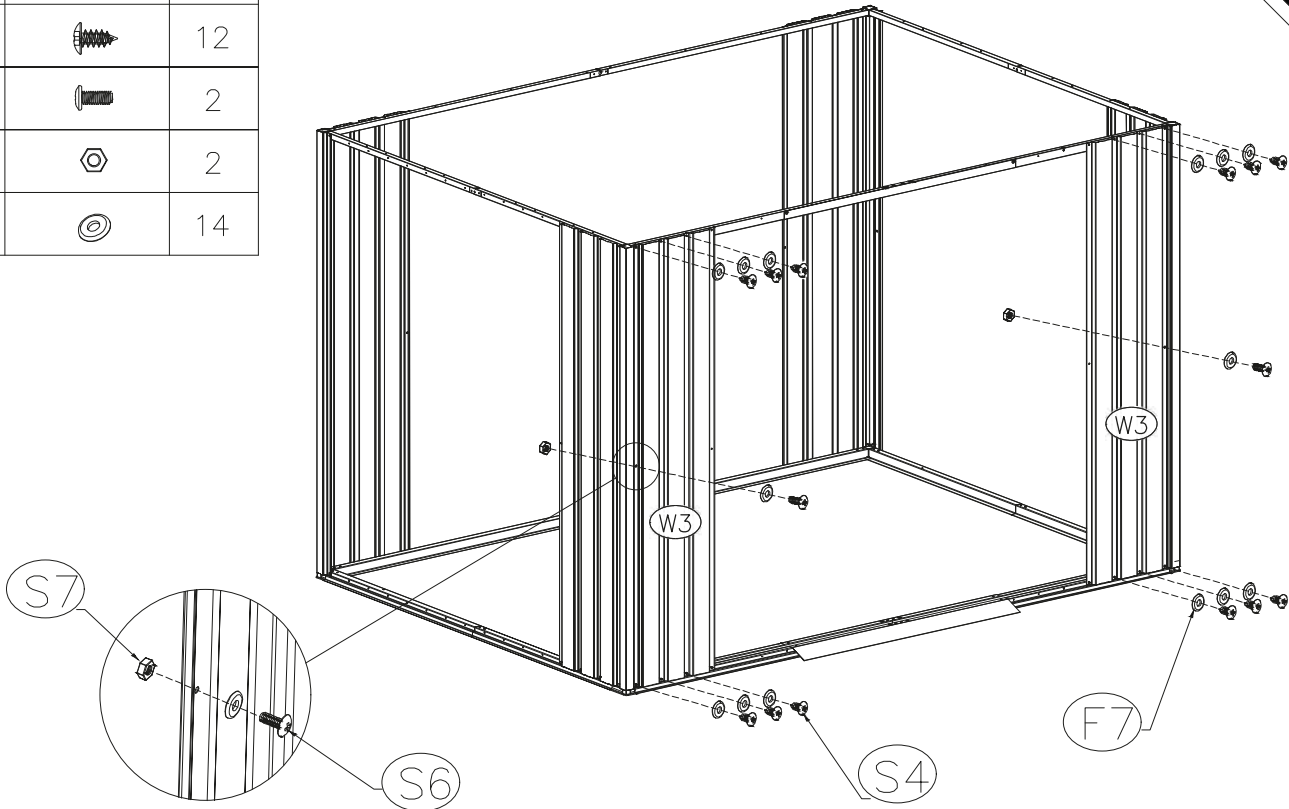







W3		2
S4		12
S6		2
S7		2
F7		14

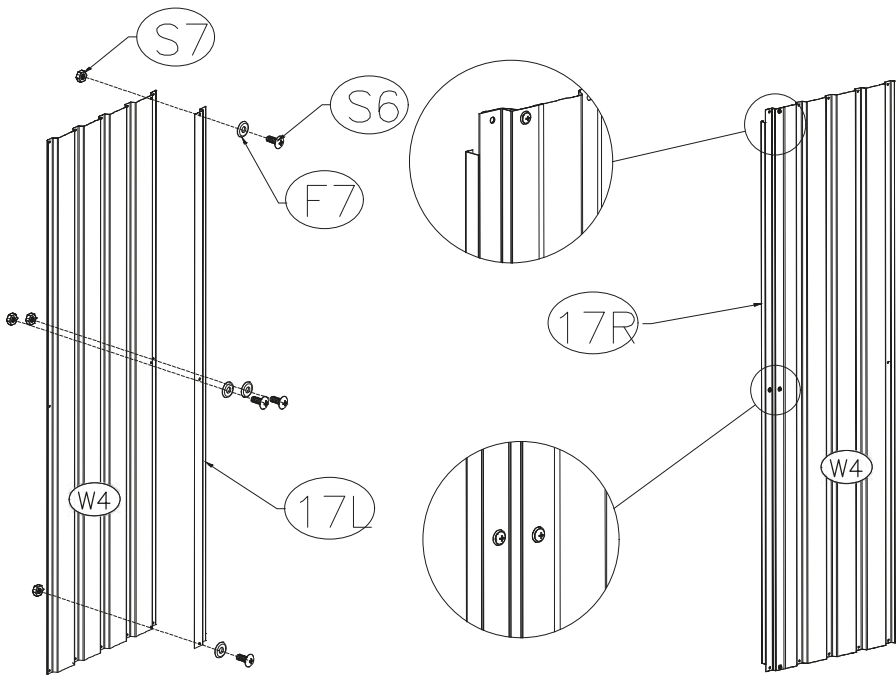





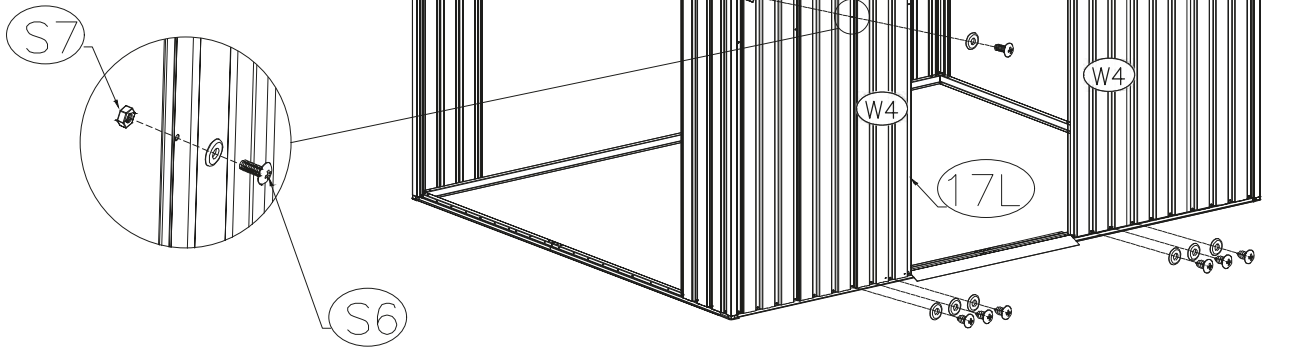

X2

17L		1
17R		1
S6		8
S7		8
F7		8







W4		2
S4		12
S6		2
S7		2
F7		14

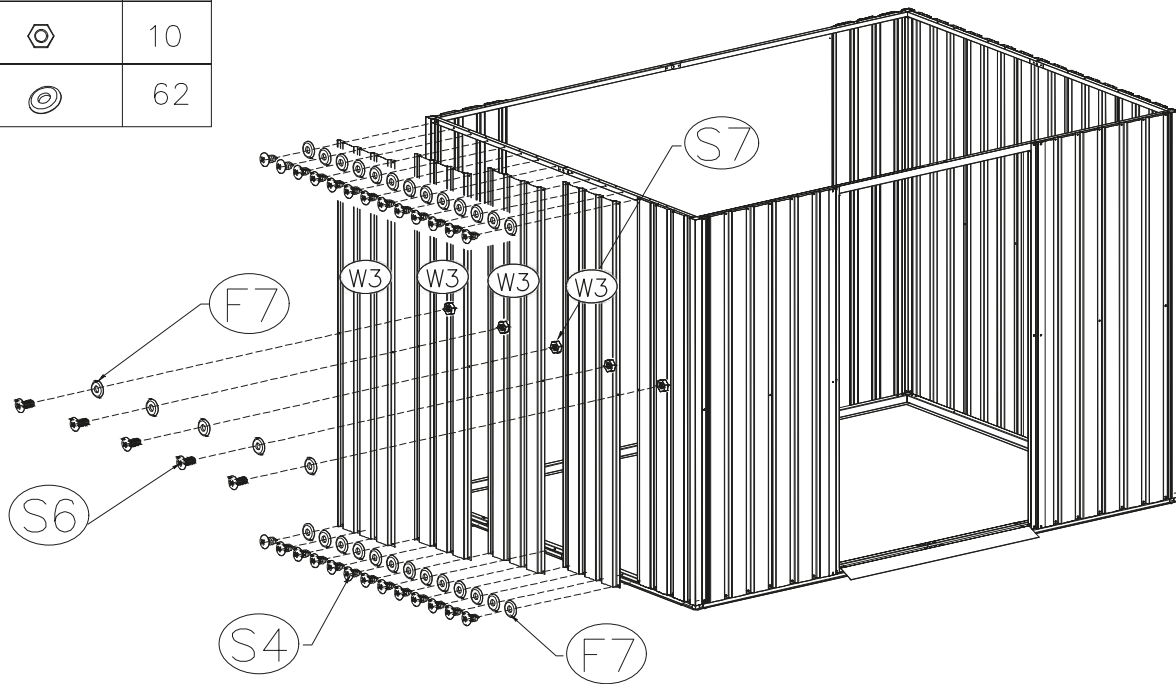







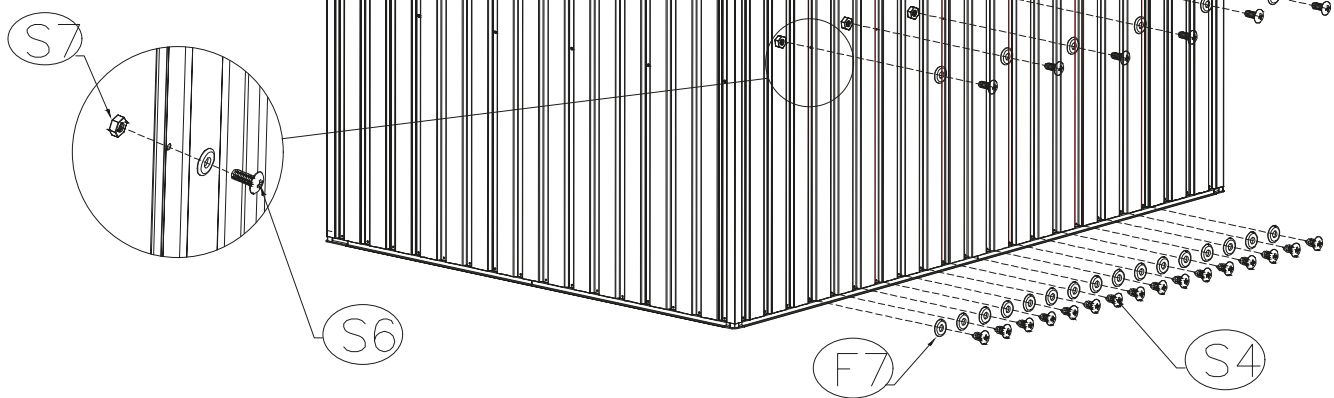

W3		8
S4		52
S6		10
S7		10
F7		62



X2

W3		5
S4		32
S6		6
S7		6
F7		38



10F		2
11L		2
11R		2
21L		2
21R		2
S6		4
S7		4

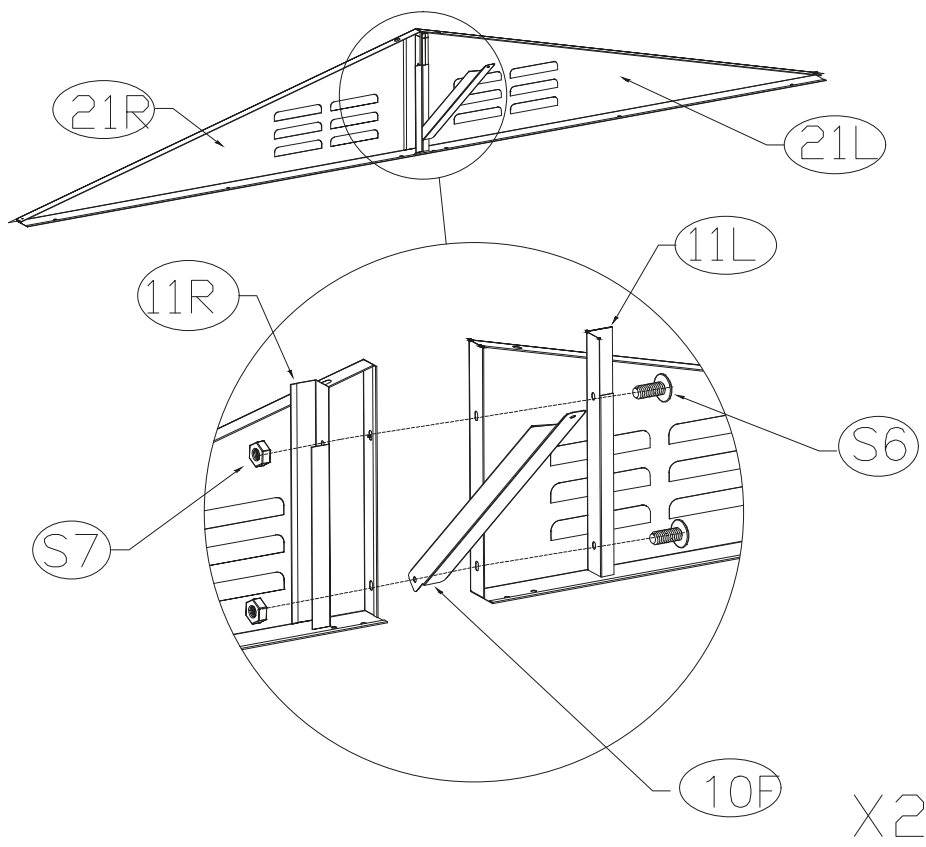

S4



20

20

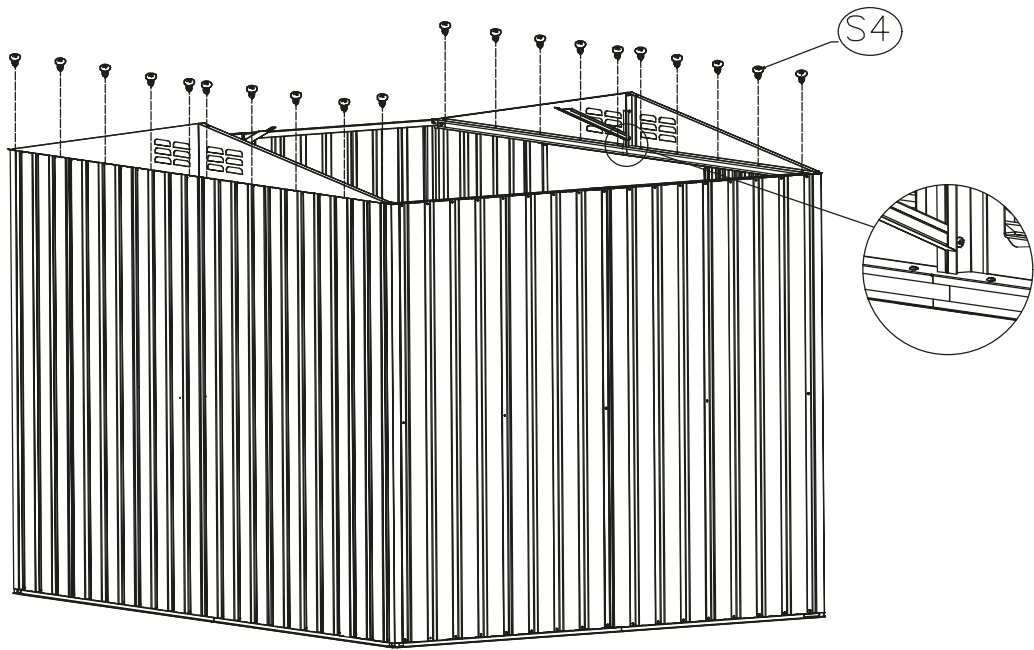

9F		1
9B		1
S6		12
S7		12

21

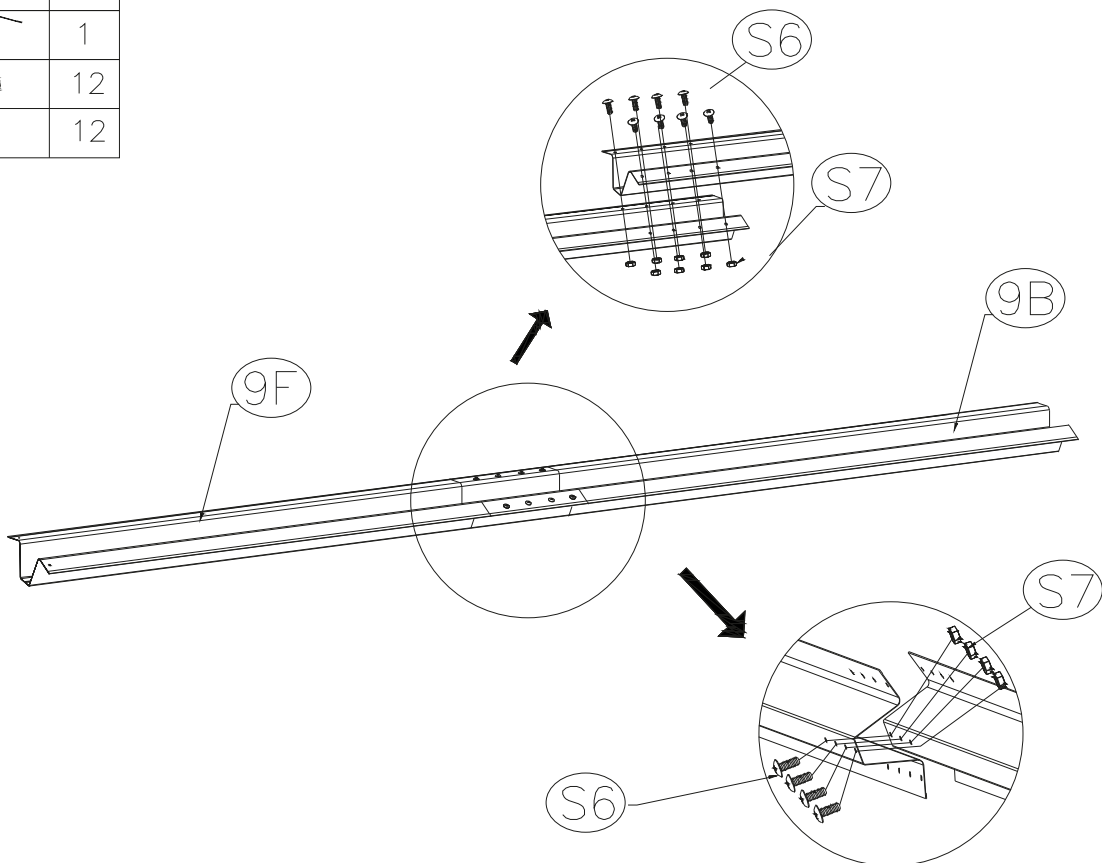

S4



2

22

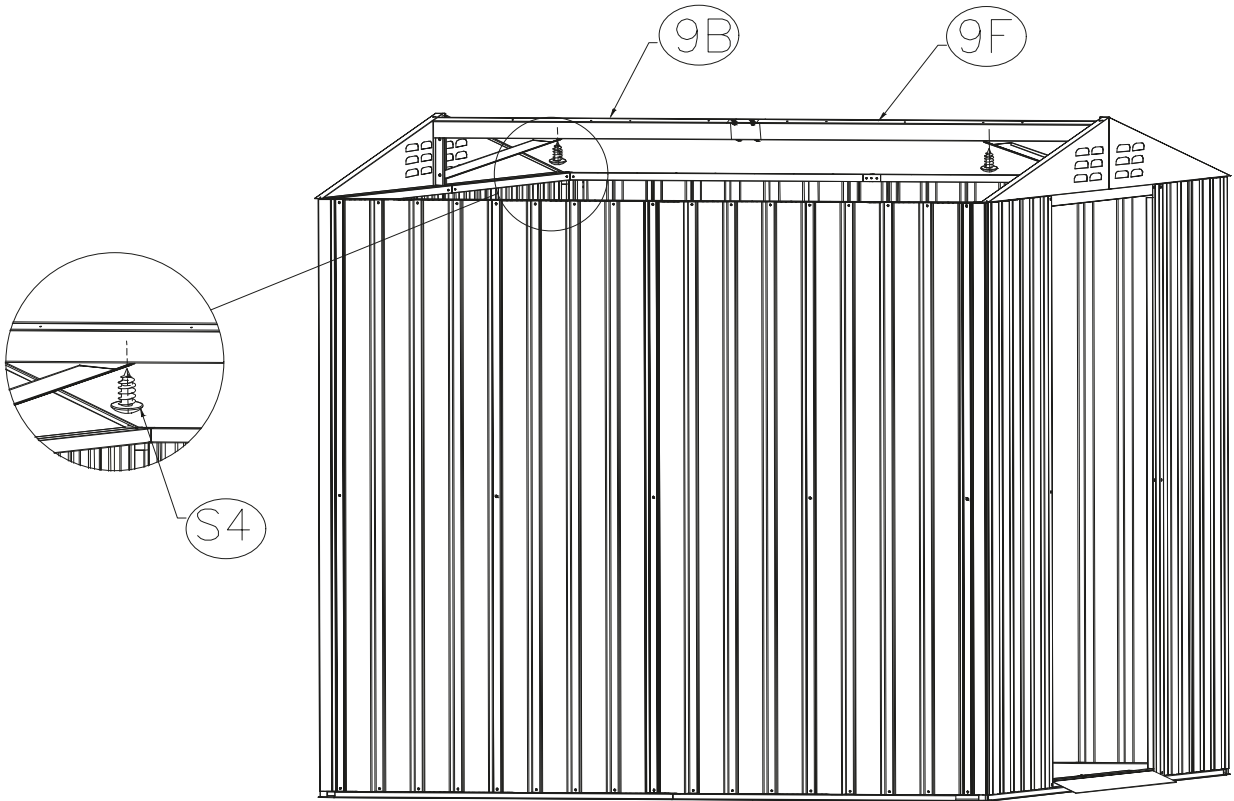

W12



2

S4



8





F7



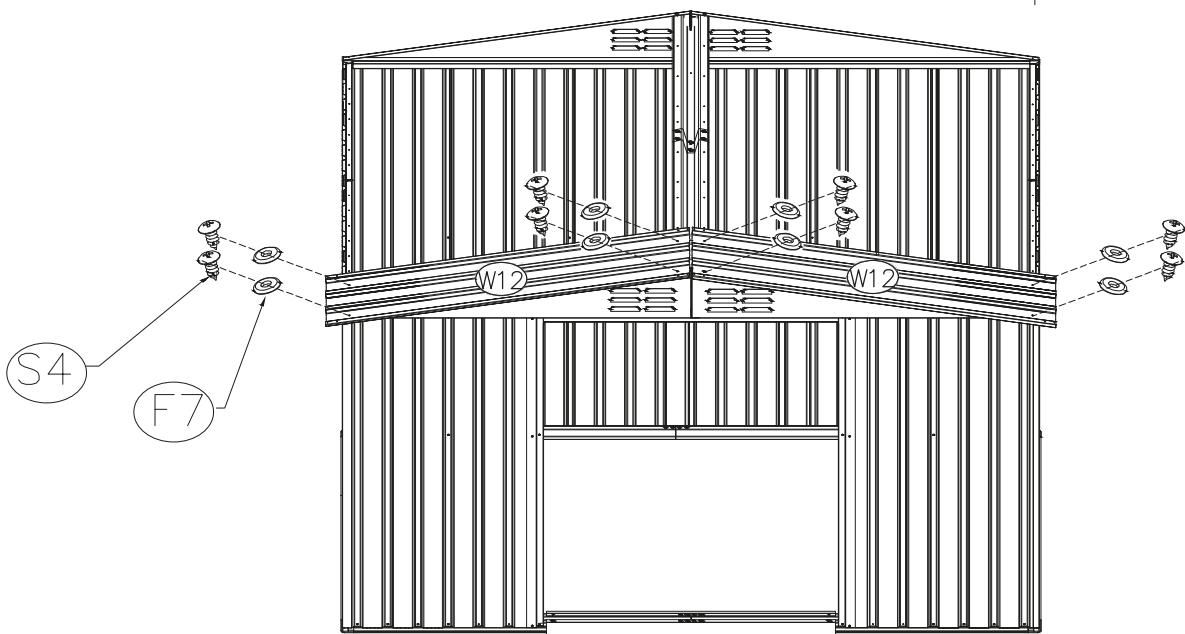
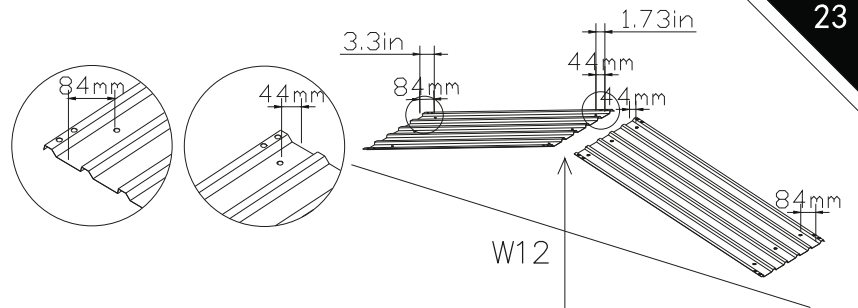



8

23

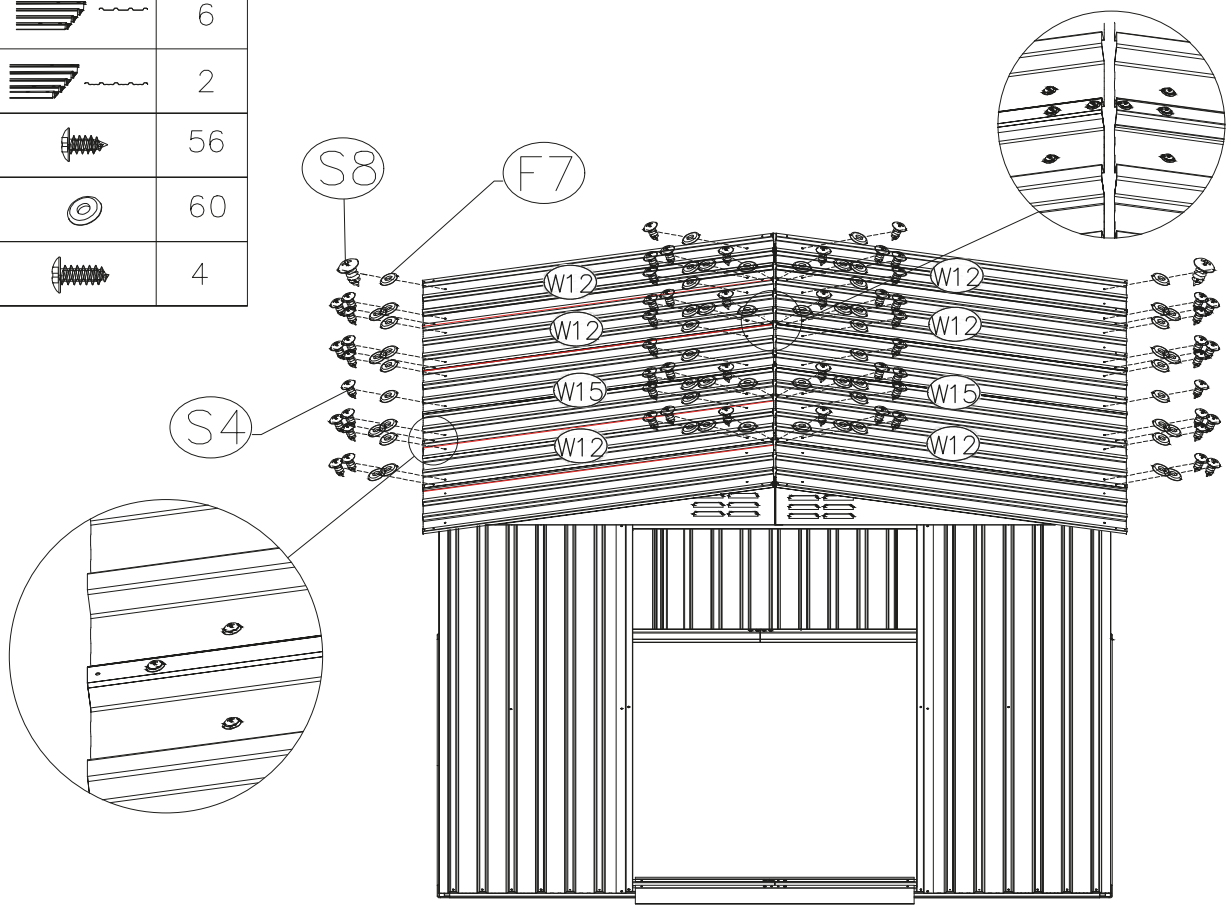

W12		6
W15		2
S4		56
F7		60
S8		4



20		4
S4		8
F7		8

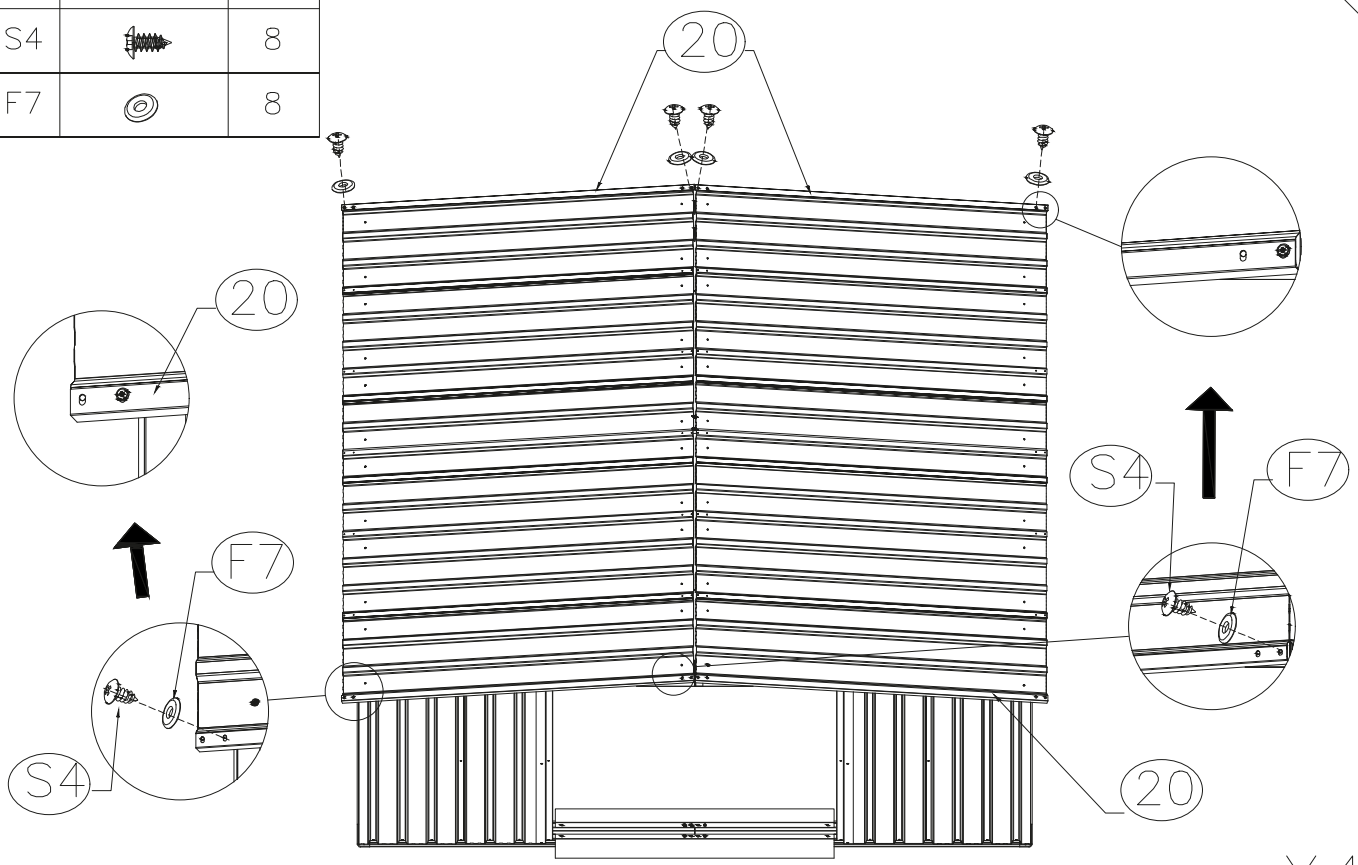

X4

19L		2
19R		2
F4		4
S4		8
S8		4
F7		6
F10		2

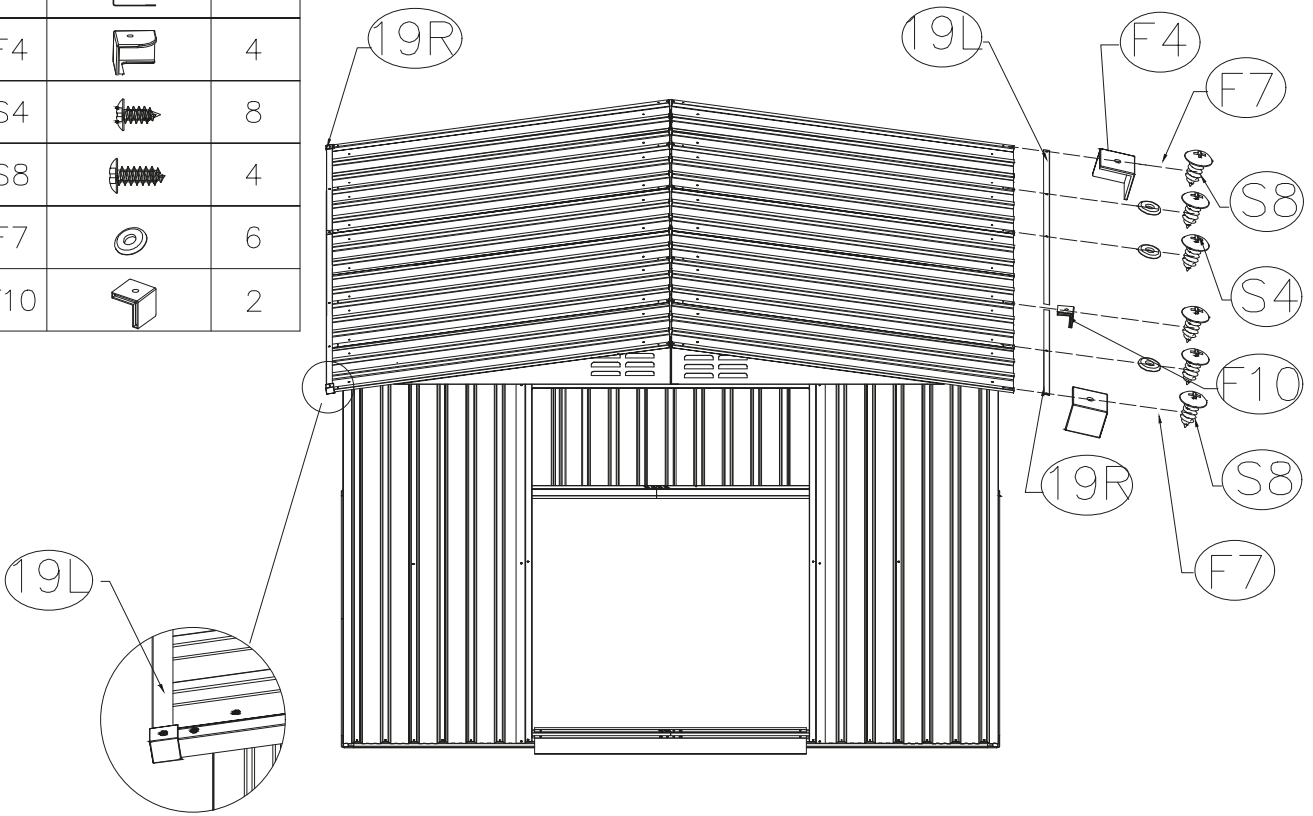

F8		34
----	--	----

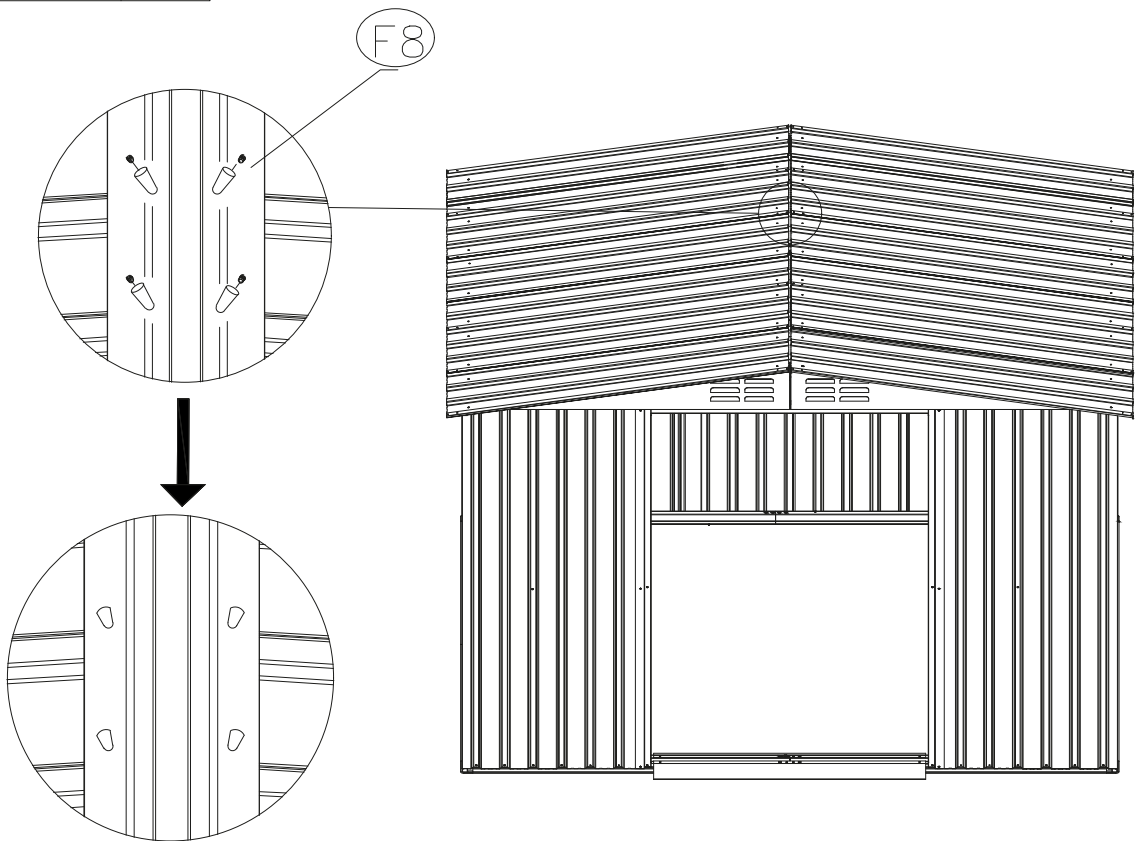

X2

F8



24

28

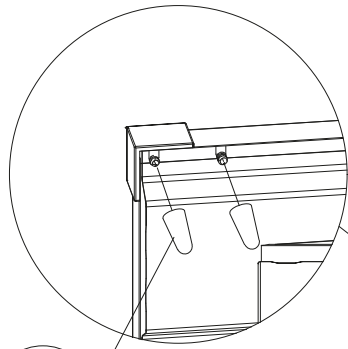

F8

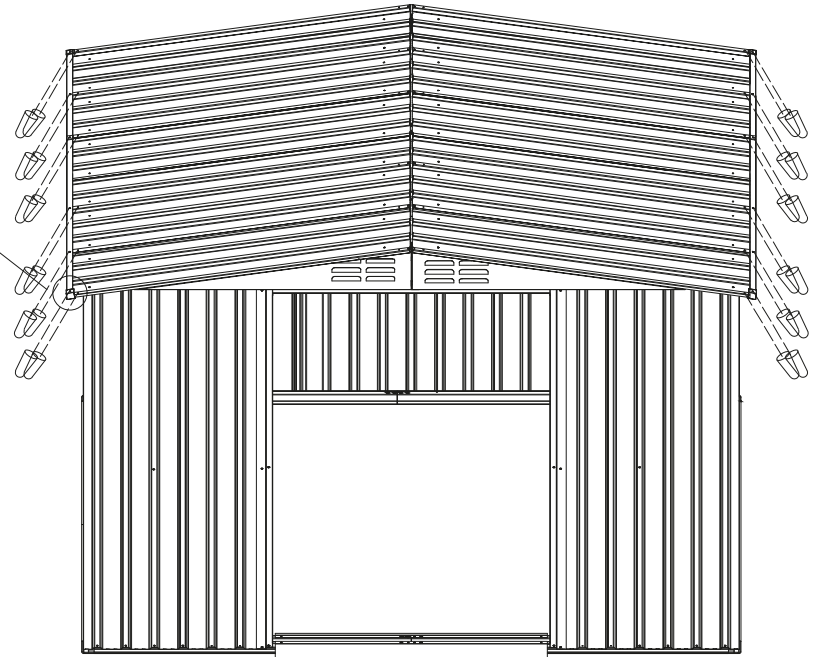
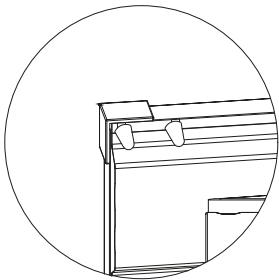

18

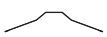

2

F5



2

S4



9

F7



9

29

S4

F5

18



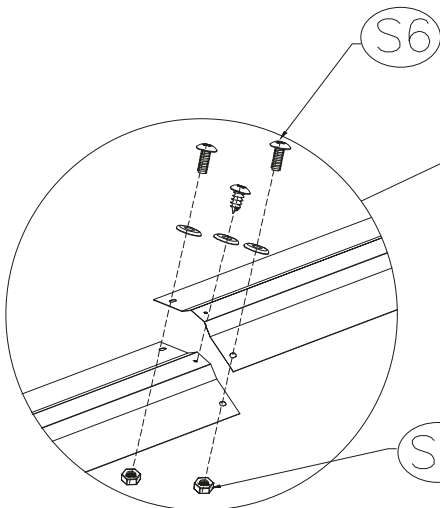



F7

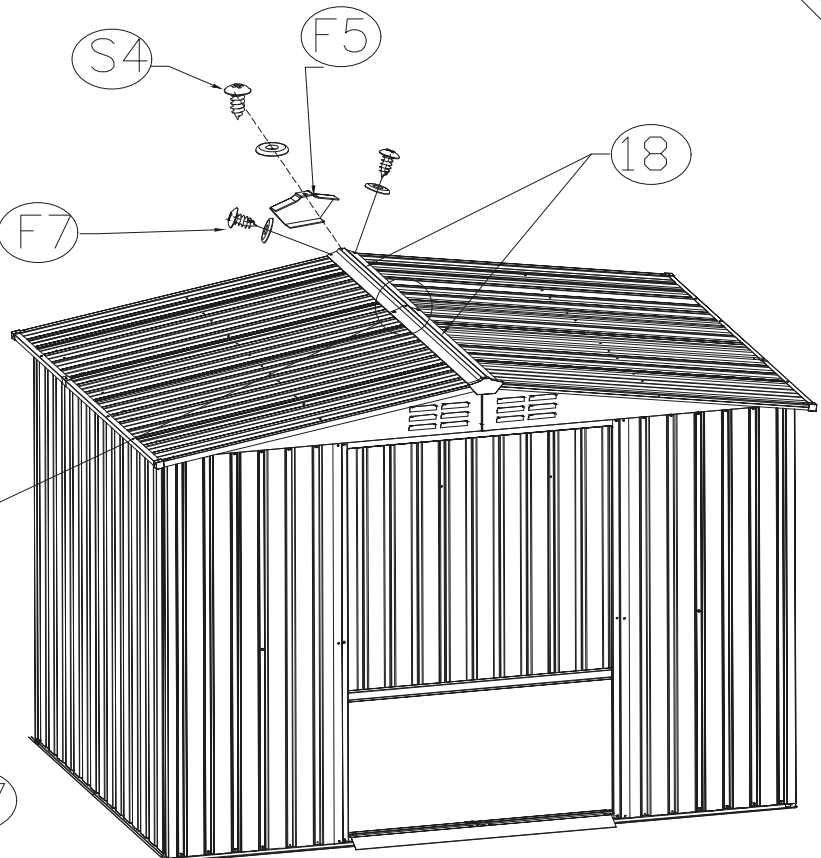





S6

S7

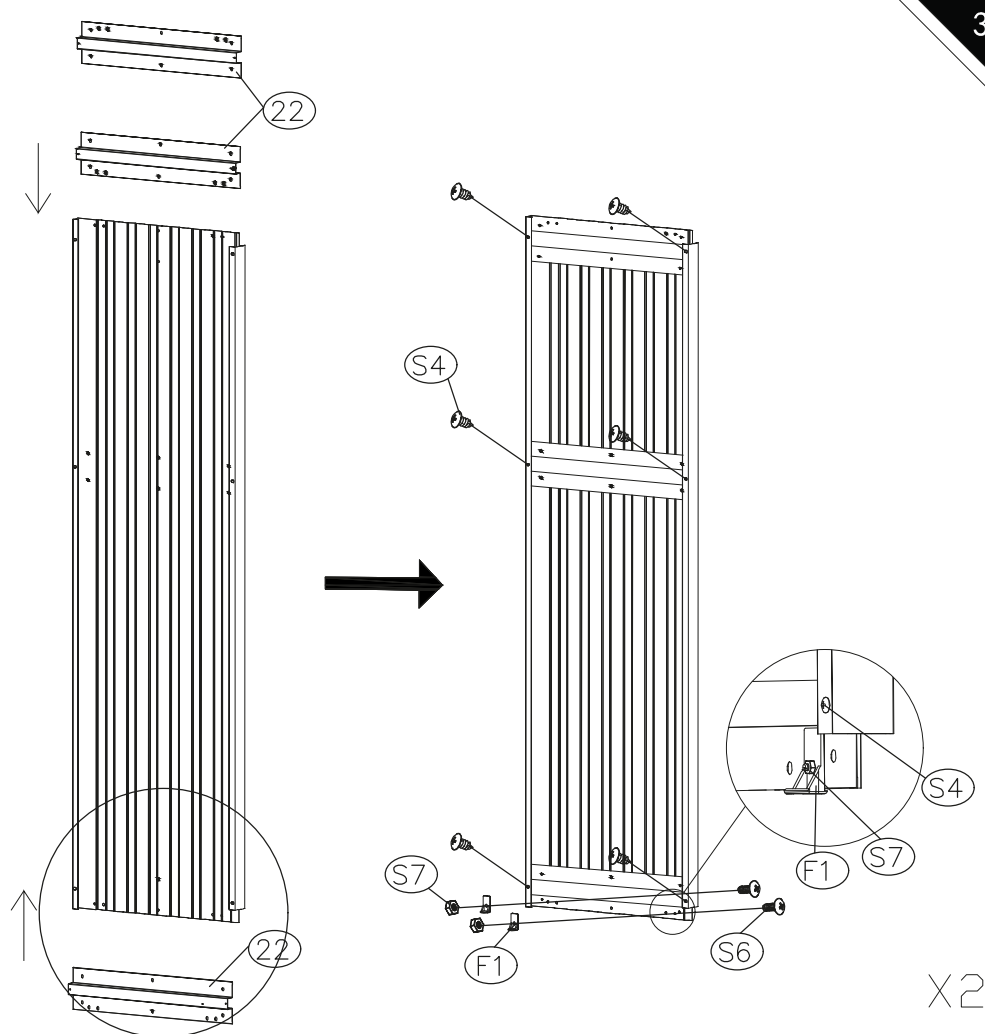
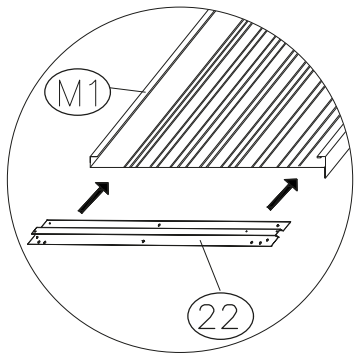



M1		1
M2		1
22		6
F1		4
S4		12
S6		8
S7		8

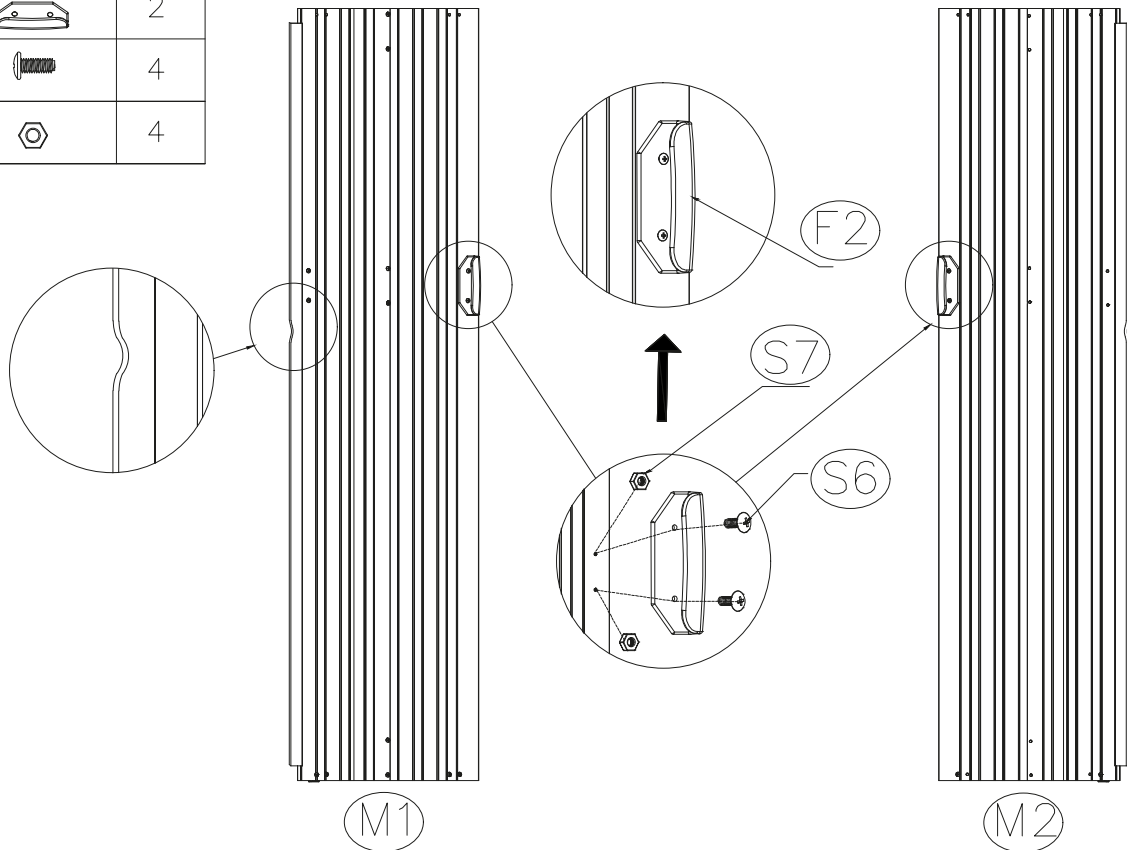

F2		2
S6		4
S7		4



S6		20
S7		20
F7		12

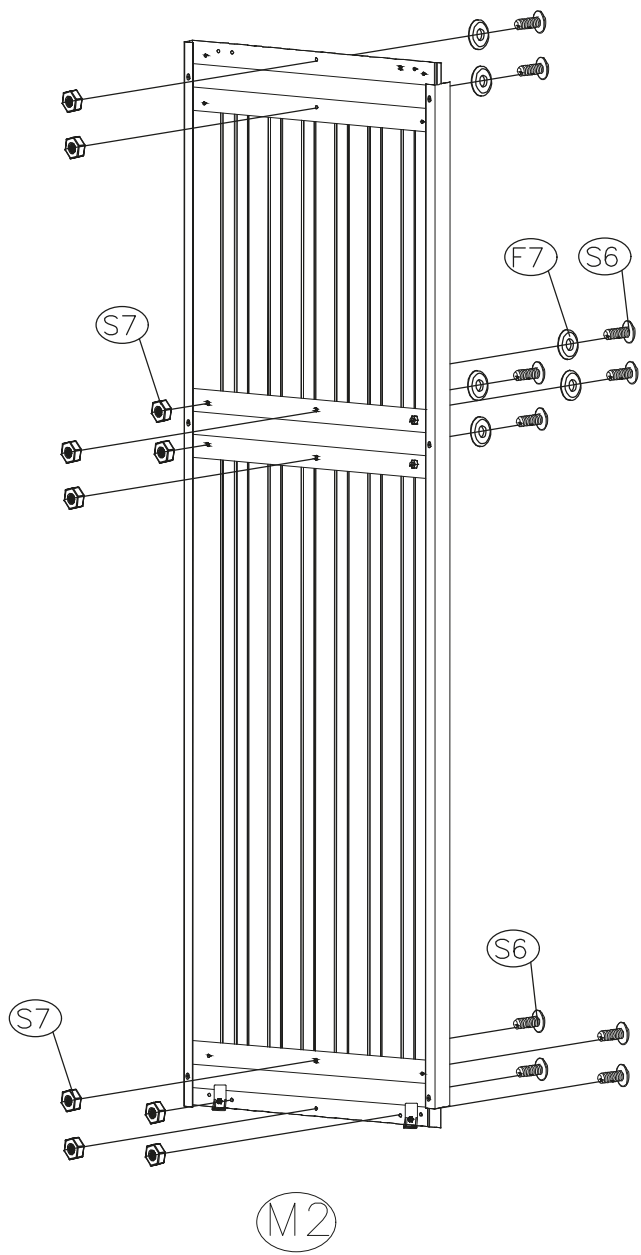
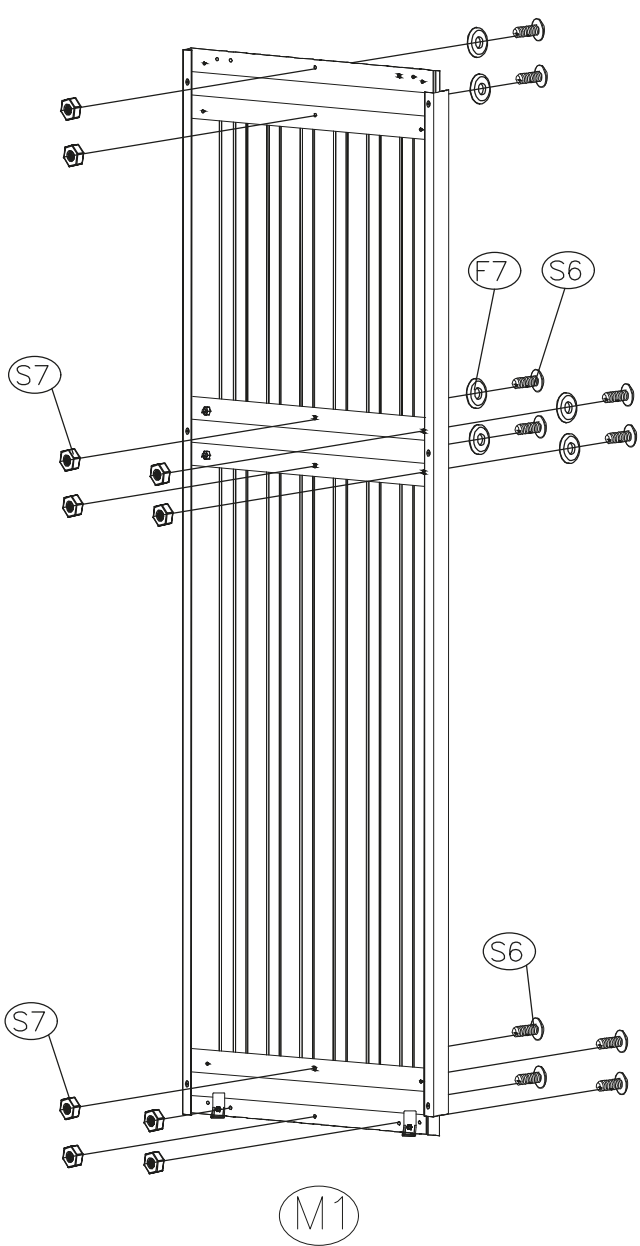

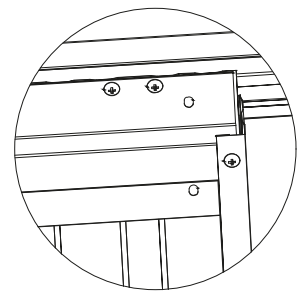
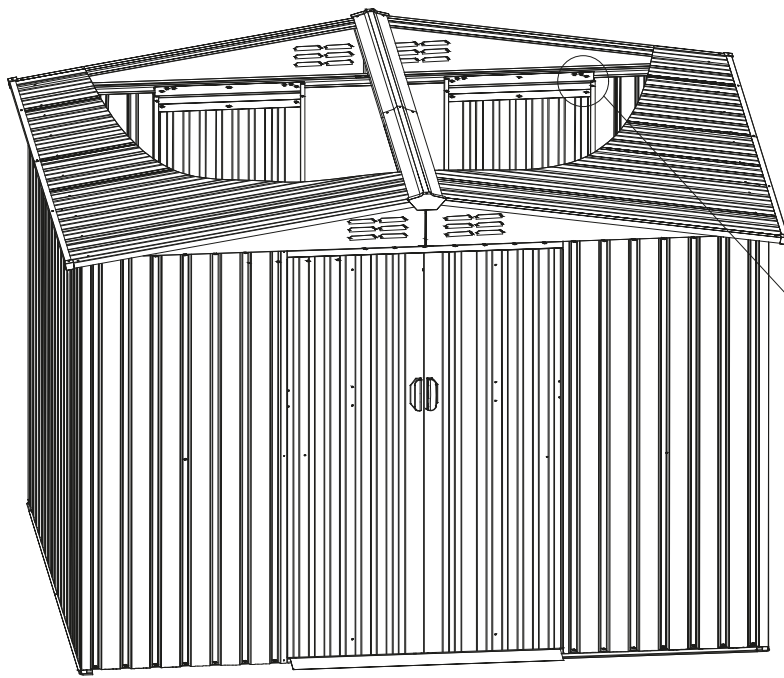

X4

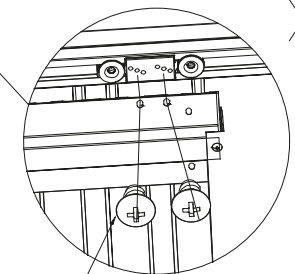

S8

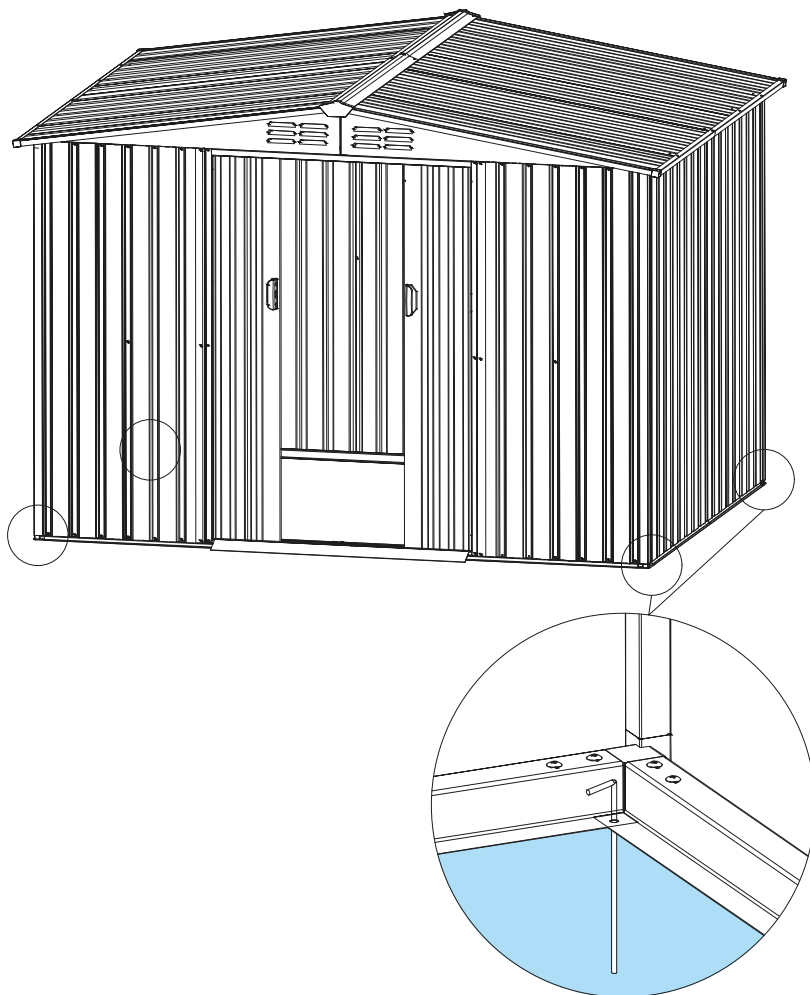

Pokud je domek instalován na trávě, může se díl [S9] použít ke zvýšení stability domku.